

YZER I

HYUNDAI ELEVATOR YZER I

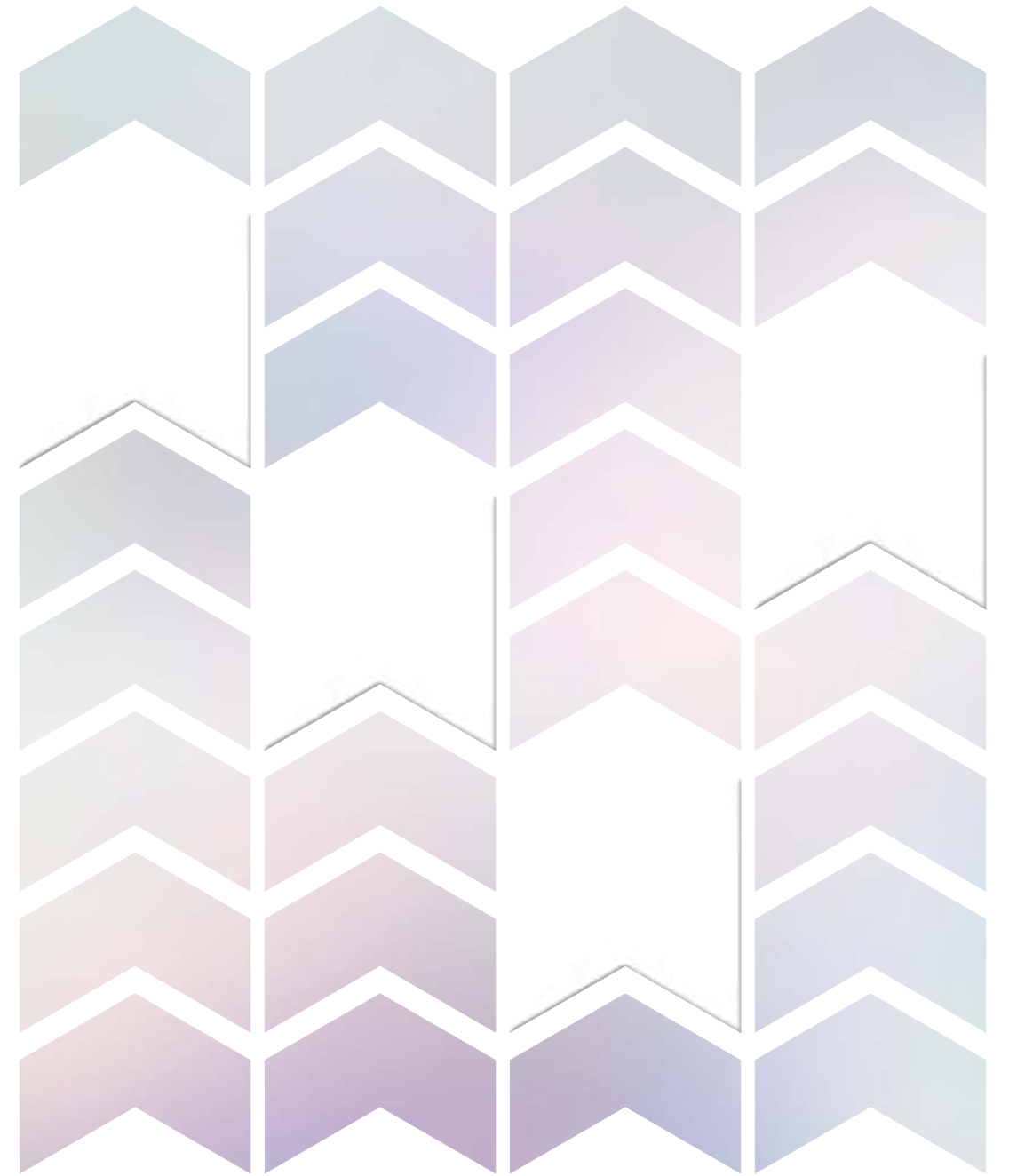

▲ HYUNDAI ELEVATOR

YZER I



Hyundai Elevator sets a new benchmark, moving beyond yesterday's concept of value. Yesterday's value which defined an elevator as a machine connecting vertical space, is fading. Hyundai Elevator presents a new standard that makes people feel safe, comfortable, and happy in elevators.

An elevator for the people: The mission of YZER I



CONTENTS

02	Why Hyundai Elevator?
04	Signature Projects
06	Cage Design of YZER I
08	YZER I - A
10	YZER I - B
12	YZER I - C
14	YZER I - D
16	Cage Design of YZER I Deluxe
18	YZER I - E
20	YZER I - F
22	YZER I - G
24	Fixtures Design
30	Options
32	Specifications
36	Global Sales & Service Network

Why Hyundai Elevator?

Factors that contribute to Hyundai Elevator's credibility and reliability.

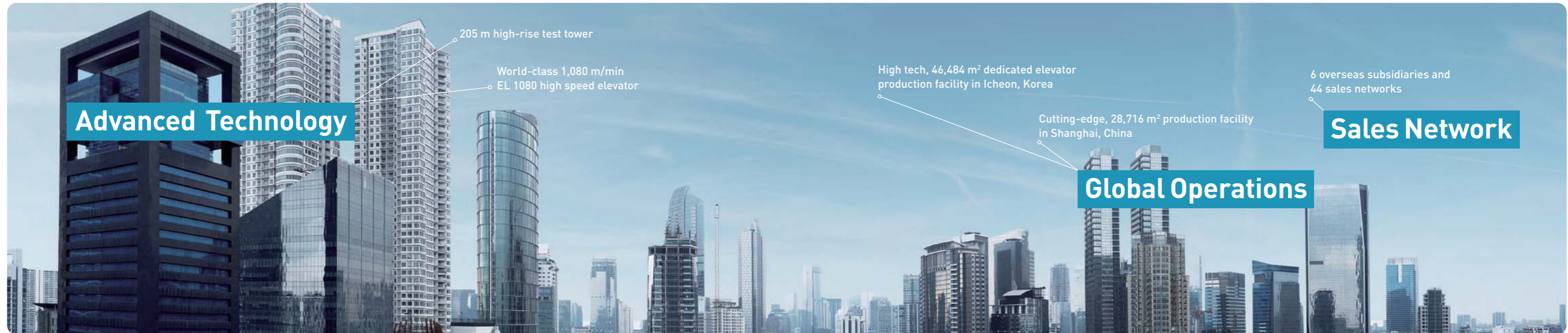

World-Class Elevator Technology

Hyundai Elevator has the world's most advanced high-speed elevator technology. It built Hyundai Asan Tower, a world-class elevator test tower, in April 2009 to thoroughly evaluate and validate the safety and reliability of its products under conditions that closely replicate those of a high-rise building.

THE EL 1080 high-speed elevator

World-class elevator (1,080 m/min.)

THE EL DUO double-deck elevator

1.8 times more loading capacity through 2 vertically integrated elevators



Production System and Sales Network that Span Across Borders

In addition to state-of-the-art production facilities in Korea, Hyundai Elevator built manufacturing facilities in China to supply its unparalleled products worldwide. The company strives to better meet the needs of global customers through localization and by maximizing synergy among its 6 overseas subsidiaries and 44 sales networks.

MANUFACTURING PLANTS

- | | |
|---|---|
| Icheon Headquarters
(Icheon, Korea) | - [Factories 1, 2, 3] 46,484 m ² state-of-the-art facilities
- Production of elevators, parking systems, etc.
- Hyundai Asan Tower
- Hyundai Customer Care Center (CCC) |
| China Factory
(Shanghai, China) | - 28,716 m ² state-of-the-art facilities
- Production of elevators and escalators
- Elevator test tower (72 m high) |
| New China Factory
(Shanghai, China)
Under Construction | - 123,564 m ² state-of-the-art facilities
- Production of elevators and escalators (annual capacity max. 25,000 units)
- Elevator test tower (185 m in total height, 175 m above ground) |

CERTIFICATION



ISO9001 ISO14001 OHSAS18001 CE

OVERSEAS SUBSIDIARIES

- | | |
|------------------|---|
| CHINA | SHANGHAI HYUNDAI ELEVATOR CO., LTD. |
| INDONESIA | PT. HYUNDAI ELEVATOR INDONESIA |
| MALAYSIA | HYUNDAI ELEVATOR (MALAYSIA) SDN. BHD |
| BRAZIL | HYUNDAI ELEVADORES DO BRASIL LTDA. |
| VIETNAM | HYUNDAI THANH CONG ELEVATOR VIETNAM CO., LIMITED |
| TURKEY | HYUNDAI ELEVATOR ASANSÖR VE SERVİS SANAYİ VE TİCARET ANONİM ŞİRKETİ |

Value proven through signature projects

Diverse projects around the world demonstrate Hyundai Elevator's competitiveness

Signature Projects

1 BUSAN INTERNATIONAL FINANCE CENTER (KOREA)

Installed 32 elevators, including two 10 m/s units (Korea's fastest), three 9 m/s units, and eight 8 m/s units, as well as 14 escalators

2 PARK HYATT BUSAN (KOREA)

Installed 11 elevators, including two 6 m/s units and three 4 m/s units

3 GALLERY WEST (INDONESIA)

Installed twenty three 4 m/s elevators, 12 escalators

4 F&F TOWER (PANAMA)

Installed five 4 m/s elevators

5 VARYAP MERIDIAN (TURKEY)

Installed 53 elevators, including seven 4 m/s units and five 3.5 m/s units

6 SEOUL DRAGON CITY (KOREA)

Installed 33 elevators, including twenty three 4 m/s units and four 3.5 m/s units, as well as 10 escalators

7 LG U+ YONGSAN OFFICE BUILDING (KOREA)

Installed 10 elevators, including 3.5 m/s double deck units (Korea's first) and four 4 m/s units, as well as 2 escalators

8 KL GATEWAY (MALAYSIA)

Installed 27 elevators, including eight 3.5 m/s, 49 escalators

9 YANGON HOTEL (MYANMAR)

Installed 20 elevators, including five 3 m/s units, two 2.5 m/s units, and six 2 m/s units

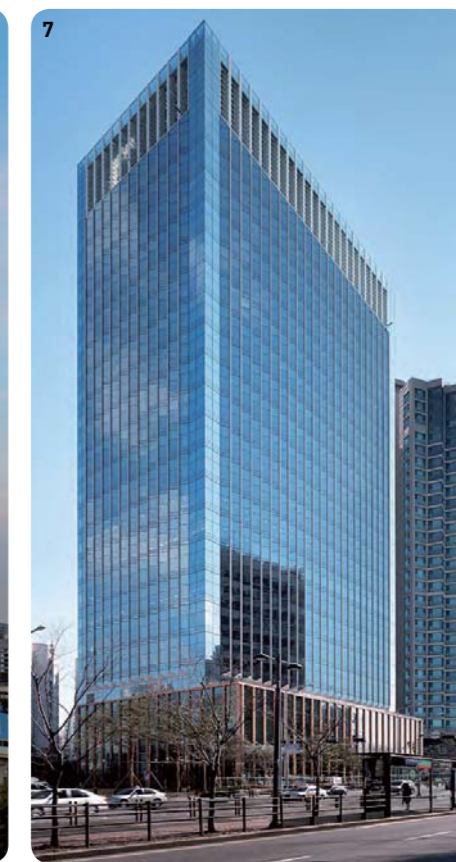

Design that blends user preferences with cutting-edge sensitivity

An elevator with a sensitive touch

Sensitive elevator that interacts with people

Hyundai Elevator places top priority on users' preferences because it considers an elevator more than a machine for moving people.

Harmonizing technology with artistry to achieve the perfect blend of beauty and comfort: this is the design philosophy behind Hyundai Elevator's YZER I.

YZER I - A



YZER I - B



YZER I - C



YZER I - D



CAR DESIGN COLLECTION

YZER I - A Type



Front Image

Rear Image

CAR DESIGN

- Ceiling** → CD198A / Aluminum (Silver),
LED Lighting, LED Down Light (4EA),
Ceiling Plate (Painted Steel / P021)
- Car Wall** → Stainless Hairline
- Handrail** → Stainless 1Pipe (1C) / Stainless
Hairline, Chrome Bracket
- Car Door** → Stainless Hairline
- Car Operating Panel** → OPP-D521 / Stainless Hairline
- Flooring** → PVC (FH-13)



200U Type

100 Type

50 Type

ENTRANCE

- 200U Type** **Jamb** → Stainless Hairline / 200U Type
- Transom Panel** → Stainless Hairline
- Door** → Stainless Hairline
- Hall Button** → HPB-621
- Indicator** → PI-D700
- 100 Type** **Jamb** → Stainless Hairline / 100 Type
- Door** → Stainless Hairline
- Hall Button** → HIP-D621
- 50 Type** **Jamb** → Stainless Hairline / 50 Type
- Door** → Stainless Hairline
- Hall Button** → HIP-D621

Note

1. Colors printed in this catalog may appear different from actual colors.
2. For 700 kg models and smaller, the central wall pattern on the inner surface of side panels may be omitted due to the division line between the 2 panels.
3. For 800 kg models and smaller, swing-type operating panels may not fit due to the narrow width of the front wall.



CAR DESIGN COLLECTION

YZER I - B Type

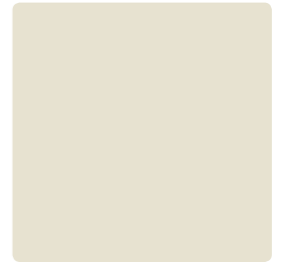

CAR DESIGN

- Ceiling** → CD199B / Stainless Hairline, LED Bar Type Module (P022), Ceiling Plate (Painted Steel / P021)
- Car Wall** → Stainless Hairline, Painted Steel / P017
- Handrail** → Stainless 1Pipe (1C) / Stainless Hairline, Chrome Bracket
- Car Door** → Painted Steel / P017
- Car Operating Panel** → OPP-D521 / Stainless Hairline
- Flooring** → PVC (FH-08)



Front Image



Rear Image

ENTRANCE

- 200U Type**
 - Jamb** → Stainless Hairline / 200U Type
 - Transom Panel** → Stainless Hairline
 - Door** → Painted Steel / P017
 - Hall Button** → HPB-621
 - Indicator** → PI-D700
- 100 Type**
 - Jamb** → Stainless Hairline / 100 Type
 - Door** → Painted steel / P017
 - Hall Button** → HIP-D621
- 50 Type**
 - Jamb** → Stainless Hairline / 50 Type
 - Door** → Painted steel / P017
 - Hall Button** → HIP-D621



200U Type



100 Type



50 Type

Note

1. Colors printed in this catalog may appear different from actual colors.
2. For 700 kg models and smaller, the central wall pattern on the inner surface of side panels may be omitted due to the division line between the 2 panels.
3. For 800 kg models and smaller, swing-type operating panels may not fit due to the narrow width of the front wall.



CAR DESIGN COLLECTION

YZER I - C Type



Front Image



Rear Image

CAR DESIGN

- Ceiling** → CD191A / Stainless Hairline, LED Bar Type Lighting, Ceiling Plate (Painted Steel / P024)
- Car Wall** → Stainless Hairline, Stainless Hairline Etching (SE2310)
- Handrail** → Stainless 1Pipe (1C) / Stainless Hairline, Chrome Bracket
- Car Door** → STS Hairline Etching (SE2310)
- Car Operating Panel** → OPP-D521 / STS Hairline
- Flooring** → PVC (FH-11)



200U Type



100 Type



50 Type

ENTRANCE

- 200U Type**
 - Jamb** → Stainless Hairline / 200U Type
 - Transom Panel** → Stainless Hairline
 - Door** → Stainless Hairline Etching (SE2310)
 - Hall Button Indicator** → HPB-621 / PI-D700
- 100 Type**
 - Jamb** → Stainless Hairline / 100 Type
 - Door** → Stainless Hairline Etching (SE2310)
 - Hall Button** → HIP-D621
- 50 Type**
 - Jamb** → Stainless Hairline / 50 Type
 - Door** → Stainless Hairline Etching (SE2310)
 - Hall Button** → HIP-D621

Note

1. Colors printed in this catalog may appear different from actual colors.
2. For 700 kg models and smaller, the central wall pattern on the inner surface of side panels may be omitted due to the division line between the 2 panels.
3. For 800 kg models and smaller, swing-type operating panels may not fit due to the narrow width of the front wall.

CAR DESIGN COLLECTION

YZER I - D Type

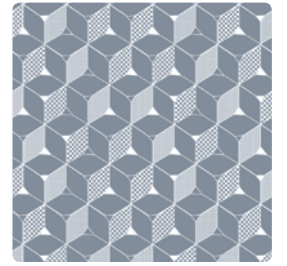

Front Image



Rear Image

CAR DESIGN

- Ceiling** → CD199B / Stainless Hairline, LED Bar Type Module (P022), Ceiling Plate (Painted Steel / P025)
- Car Wall** → Stainless Hairline, Stainless Hairline Etching (SE2312)
- Handrail** → 1FW (Optional) / Virus-Resistant Single Bar (Wood Pattern), Aluminum Bracket
- Car Door** → Stainless Hairline Etching (SE2312)
- Car Operating Panel** → OPP-N321
- Flooring** → PVC (FH-10)
- Indicator** → PI-L210 (Optional) / Smart Indicator, Anion Air Cleaner, Ultrasonic Pest Repellent



200U Type



100 Type



50 Type

ENTRANCE

- 200U Type**
 - Jamb** → Stainless Hairline / 200U Type
 - Transom Panel** → Stainless Hairline
 - Door** → Stainless Hairline Etching (SE2312)
 - Hall Button** → HPB-A21
 - Indicator** → PI-D700
- 100 Type**
 - Jamb** → Stainless Hairline / 100 Type
 - Door** → Stainless Hairline Etching (SE2312)
 - Hall Button** → HIP-DA21
- 50 Type**
 - Jamb** → Stainless Hairline / 50 Type
 - Door** → Stainless Hairline Etching (SE2312)
 - Hall Button** → HIP-DA21

Note

1. Colors printed in this catalog may appear different from actual colors.
2. For 700 kg models and smaller, the central wall pattern on the inner surface of side panels may be omitted due to the division line between the 2 panels.
3. For 800 kg models and smaller, swing-type operating panels may not fit due to the narrow width of the front wall.

YZER I delivers a more sophisticated experience
Deluxe elevator with a luxurious sense of space

Spaces created with differentiated designs and materials and attention to details.

Hyundai Elevator can maximize a building's value by delivering beauty and comfort at the same time with technology that is optimized for mobility.

YZER I's deluxe models impress their users with spaces that are more luxurious and filled with fine details.

YZER I - E



YZER I - F



YZER I - G



CAR DESIGN COLLECTION

YZER I - E Type



Front Image



Rear Image

CAR DESIGN

- Ceiling** → CD253A/SUB Ceiling (Painted Steel P022), Ceiling Plate (Painted Steel P022)
- Left Side** → TI-Black STS Hairline/ STS Mirror Trimmed
- Right Side** → TI-Black STS Hairline/ STS Mirror Trimmed
- Rear Side** → TI-Black STS Hairline/TI-Black STS Mirror/STS Mirror Trimmed
- Front Side** → TI-Black STS Hairline
- Column** → STS Mirror
- Car Door** → TI-Black STS Hairline
- Car Operating Panel** → OPP-D521/TI-Black STS Hairline
- Flooring** → PVC (FH-09)



200U Type

100 Type

50 Type

ENTRANCE

- 200U Type Jamb** → TI-Black STS Hairline/ 200U Type
- Transom Panel** → TI-Black STS Hairline
- Door** → TI-Black STS Hairline
- Hall Button** → HPB-A21
- Indicator** → PI-D700
- 100 Type Jamb** → TI-Black STS Hairline/ 100 Type
- Door** → TI-Black STS Hairline
- Hall Button** → HIP-DA21
- 50 Type Jamb** → TI-Black STS Hairline/ 50 Type
- Door** → TI-Black STS Hairline
- Hall Button** → HIP-DA21

Note
 1. Colors printed in this catalog may appear different from actual colors.
 2. For 700 kg models and smaller, the central wall pattern on the inner surface of side panels may be omitted due to the division line between the 2 panels.
 3. For 800 kg models and smaller, swing-type operating panels may not fit due to the narrow width of the front wall.



CAR DESIGN COLLECTION

YZER I - F Type

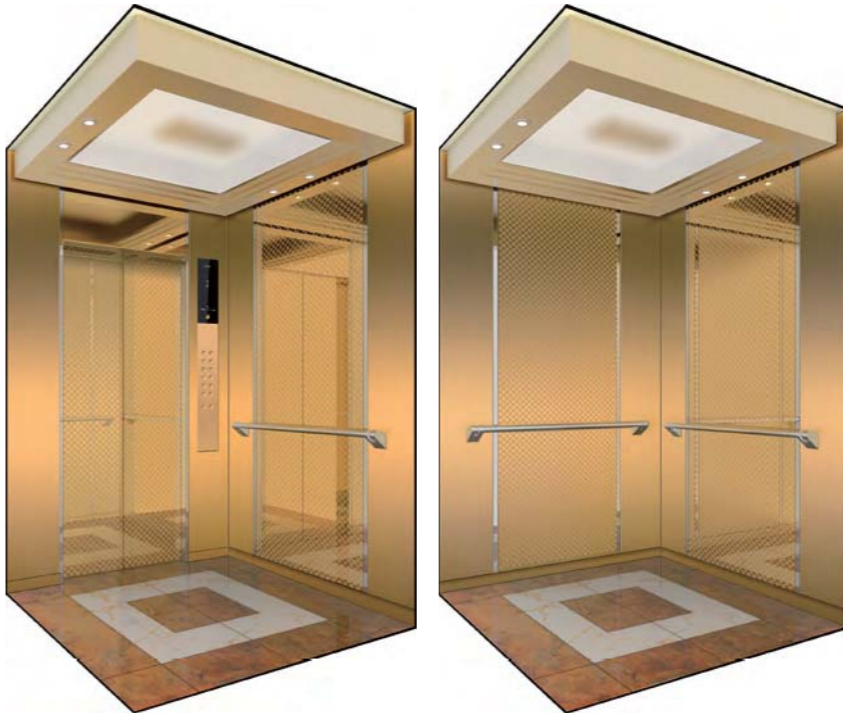

Front Image

Rear Image

CAR DESIGN

- Ceiling** → CD245AS/SUB Ceiling (TI-Gold STS Hairline), Ceiling Plate (Painted Steel P017)
- Left Side** → TI-Gold STS Hairline/TI-Gold STS Mirror Etching (SE1673)/STS Mirror Trimmed
- Right Side** → TI-Gold STS Hairline/TI-Gold STS Mirror Etching (SE1673)/STS Mirror Trimmed
- Rear Side** → TI-Gold STS Hairline/TI-Gold STS Hairline Etching (SE1673)/STS Mirror Trimmed
- Front Side** → TI-Gold STS Hairline/TI-Gold STS Mirror
- Column** → STS Mirror
- Handrail** → HR-01A/TI-Gold STS Hairline/Three Sides
- Car Door** → TI-Gold STS Mirror Etching (SE1673)
- Car Operating Panel** → OPP-D521/TI-Gold STS Hairline
- Flooring** → PVC (FH-12)



200U Type

100 Type

50 Type

ENTRANCE

- 200U Type**
 - Jamb** → TI-Gold STS Hairline/200U Type
 - Transom Panel** → TI-Gold STS Hairline
 - Door** → TI-Gold STS Hairline Etching (SE1673)
 - Hall Button Indicator** → HPB-B21 / PI-D800
- 100 Type**
 - Jamb** → TI-Gold STS Hairline/100 Type
 - Door** → TI-Gold STS Hairline Etching (SE1673)
 - Hall Button** → HIP-DB21
- 50 Type**
 - Jamb** → STS Hairline/50Type
 - Door** → TI-Gold STS Hairline Etching (SE1673)
 - Hall Button** → HIP-DB21

Note
 1. Colors printed in this catalog may appear different from actual colors.
 2. For 700 kg models and smaller, the central wall pattern on the inner surface of side panels may be omitted due to the division line between the 2 panels.
 3. For 800 kg models and smaller, swing-type operating panels may not fit due to the narrow width of the front wall.

CAR DESIGN COLLECTION

YZER I - G Type



Front Image

Rear Image

CAR DESIGN

- Ceiling** → CD399A/Barrisol, Sub Ceiling (Painted Steel P022), Led Lighting, Ceiling Plate (Painted Steel P024)
- Car Wall** → STS Bead Blast, Art Metal Black (AM01), Embo STS (EP01)
- Handrail** → 1LB/Anti-Virus Bar (Metallic Black), Aluminium Bracket, LED Lighting (Option)
- Car Door** → STS Bead Blast
- Car Operating Panel** → OPP-N280A (Swing Type)/ STS Bead Blast
- Indicator** → PI-L210/Anion Air Cleaner, Ultrasonic Pest Repellent
- Flooring** → PVC (FH-13)



200U Type

100 Type

50 Type

ENTRANCE

- 200U Type**
 - Jamb** → STS Bead Blast/200U Type
 - Transom Panel** → STS Bead Blast
 - Door** → STS Bead Blast
 - Hall Button** → HTB-C100
 - Indicator** → PI-D900
- 100 Type**
 - Jamb** → STS Bead Blast/100 Type
 - Door** → STS Bead Blast
 - Hall Button** → HIT-DC100
- 50 Type**
 - Jamb** → STS Bead Blast/50 Type
 - Door** → STS Bead Blast
 - Hall Button** → HIT-DC100

Note

1. Colors printed in this catalog may appear different from actual colors.
2. For 700 kg models and smaller, the central wall pattern on the inner surface of side panels may be omitted due to the division line between the 2 panels.
3. For 800 kg models and smaller, swing-type operating panels may not fit due to the narrow width of the front wall.



YZER I
FIXTURES DESIGN

Car Operating Panels

Deluxe

D: DOT TYPE / L: LCD TYPE



Standard

D: DOT TYPE / L: LCD TYPE

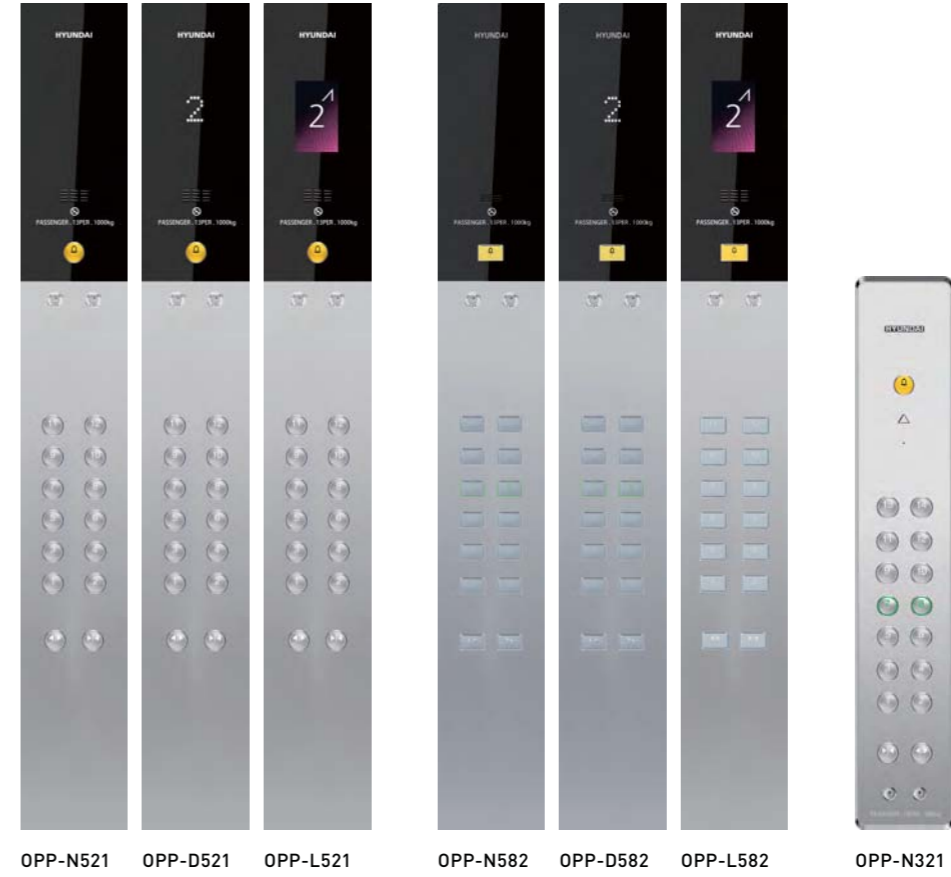

Buttons

Deluxe

*The surface of 66 type buttons is convex. 80 type buttons are applicable to NON-CODE only



66 Type (Korea)
*With sensor

80 Type (Korea)
*With sensor

Standard

*The surface of 21 type buttons is concave. The surface of 64 buttons is convex. 82 type buttons are applicable to NON-CODE only



21 Type

64 Type

82 Type

YZER I
FIXTURES DESIGN

Hall Buttons

Deluxe

D: DOT TYPE / L: LCD TYPE

Box Type



HIP-LT264C HIP-LT264CW

Boxless Type



HIP-LC21 HIP-LC21W

Standard

D: DOT TYPE / L: LCD TYPE

Box Type



HPB-264C/HIP-D264C

Boxless Type



HPB-B64 HIP-DB64 HPB-A21/HIP-DA21



HPB-621/HIP-D621 HPB-821/HIP-D821 HIP-DA64W

Indicators

Deluxe

D: DOT TYPE / L: LCD TYPE

Box Type



PI-L210
 Applicable to center open only
 (JJ=700, 800, 900, 1000,
 1100, 1200)
 *For the inside of the car only.

Standard

D: DOT TYPE / L: LCD TYPE

Box Type



PI-D110/PI-D310



PI-D800

Boxless Type



PI-D700



PI-L700 (Korea)



PI-D600/PI-D610

Hall Lanterns

Box Type



HLS-640 HLS-770

Boxless Type



HLS-790

YZER I
FIXTURES DESIGN

Ceiling

Standard



CD198A
 CA≥1100, CB≥1000



CD199A
 CA≥1100, CB≥850, Without safety window
 CA≥1100, CB≥1100, With safety window



CD199B
 CA≥1100, CB≥850, Without safety window
 CA≥1100, CB≥1250, With safety window

Optional



CD191A
 CA≥1000, CB≥850, Without safety window
 CA≥1100, CB≥1250, With safety window



CD451B
 CA≥1200, CB≥850, Without safety window



CD399A
 CA≥1100, CB≥850, Without safety window
 CA≥1100, CB≥1200, With safety window
 [Imported from Korea]



CD219A
 CA≥1200, CB≥850, With safety window



CD245AS
 CA≥1050, CB≥1050, Without safety window



CD253A
 CA≥1200, CB≥850, Without safety window
 CA≥1400, CB≥1200, With safety window

Handrail



HR-BAR
 Hairline finish stainless steel



1C
 Hairline finish stainless steel



1FW
 [Imported from Korea]



1LB
 [Imported from Korea]

Flooring Design

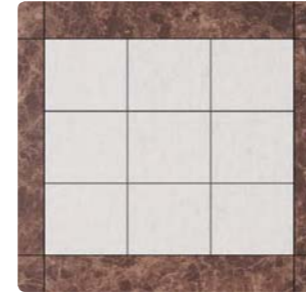

FH-01



FH-02



FH-08

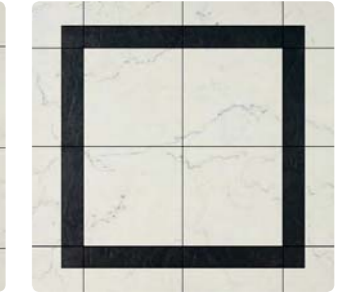

FH-09

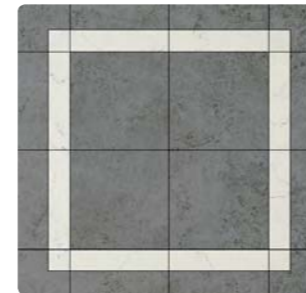

FH-10



FH-11



FH-12



FP-08

Painted Steel

Standard Color



P003



P005



P017

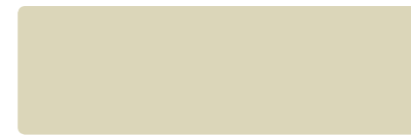

P019



P022



P033

Metal Color



P020



P021



P024

YZER I

OPTIONS

SMART INDICATOR (OPTIONAL)



Time / Date Info Display

An LCD display improves user convenience by providing easy access to information such as date, time, and floor. It boasts a sophisticated design and dramatically enhanced readability.

Smart care for health

Double-clean system maintains clean air in the elevator

Double-Clean System Equipped with Air-Cleaning and Antiseptic Functions

An anion-generating Air Cleaner that works year-round and an indicator combines to produce an all-in-one design. Clean interior air quality is maintained through the complete elimination of undesirable active oxygen and germs.

Visual recognition of system operation is easy since Air-Clean, Anion, and Anti-Virus are displayed in sequence.

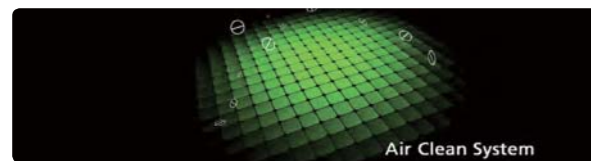

- Over 100,000 anions are released per 1 cc of air, keeping air clean and fresh at all times.
- More than 99% of harmful substances, including viruses, are removed (after four hours' operation).
- This system achieves eliminating malodorous substances.

Smart care for safety

Smart Indicator helps passengers to see safety functions with their own eyes.



CCTV Security Info Display System

When CCTV is operated, the Smart Indicator displays a CCTV graphic. This prevents crime by alerting people for potential crimes in a closed space.

* CCTV Security Info Display System requires installation of CCTV (optional).



Ultrasonic Pest-Repellent Function

Colorless and odorless ultrasonic waves eradicates, mosquitoes and other pests, to create a pleasant interior space, which up to now was hard to achieve due to frequent door-opening.

IBS SYSTEM (CARD KEY)



IBS System (Card key)

It enables effective security and crime prevention by limiting entry/exit by outsiders.

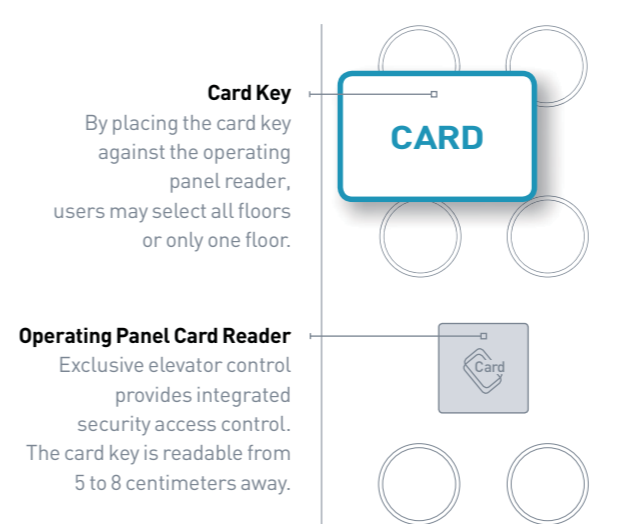

BLACK BOX-TYPE CCTV/ MULTI-BEAM DOOR SAFETY DEVICE



Black Box-Type CCTV

CCTV camera records all elevator activity including passengers, ensuring security control on a real-time basis.

Multi-Beam Door Safety Device

Multibeam sensor detects passenger movement and automatically opens the door, helping prevent accidents.

Minimal Space, Maximum Value!

In 1999, Hyundai Elevator introduced the YZER, Korea's first MRL (Machine Room Less) elevator. In 2015, the company rewrote MRL history with the introduction of the YZER I. By minimizing hoistway size, the YZER I reduces spatial needs while increasing customer value.



Enhanced Safety through the Application of International Standards

- Guaranteed safe operation by using ropes that meet international standards

Simple Installation, Fast Delivery

- Application of rail mounting-type traction system
 - Easy to set up because beam sleeve installation at top of the hoistway is not necessary
- 20% shorter installation period
 - Not necessary to build footholds at the top and bottom of the hoistway
 - Simplified process through the use of jigs for exclusive use



Less burden on construction design and lower construction costs

- Minimum hoistway size

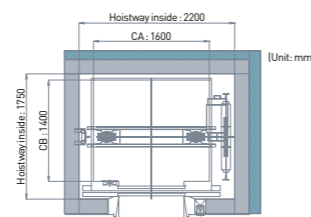

21% reduction in hoistway (1000kg capacity elevator)

- Minimum pit depth (1150 mm)

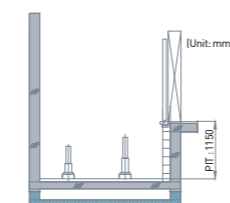

350 mm reduction in depth (≤1150kg, 1.0m/s)

Easier maintenance and improved customer safety

- A high-performance, eco-friendly traction machine with a proven track record
 - Oil-free traction system not requiring regular oiling of the bearing unit
 - Easier to maintain because on-site brake adjustment is not necessary

Hoistway Plan and Section

YZER I's hoistway, which exploits minimal space, is the product of extensive R&D by Hyundai Elevator's leading technical experts. Besides contributing to superior performance and riding comfort, it achieves a refined architectural design. The end result is the most efficient use of building space, lower construction costs, and easier maintenance.

Layout of Hoistway

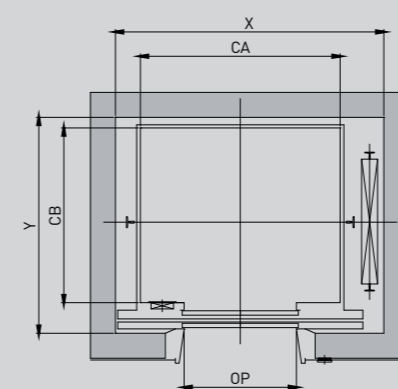

[TYPICAL FLOORS]

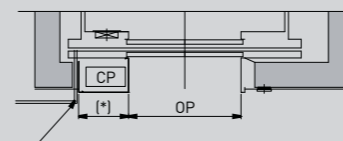

[TOP FLOOR]

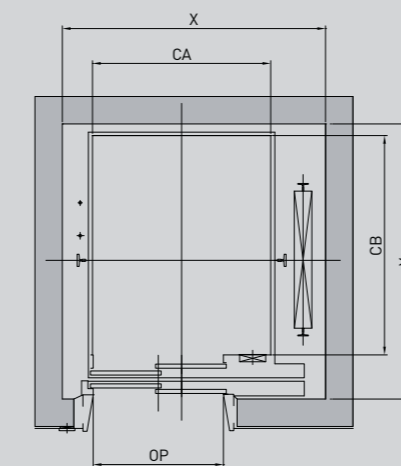

[TYPICAL FLOORS]

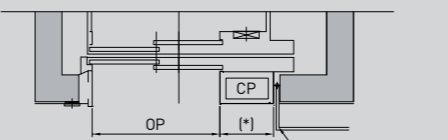

[TOP FLOOR]

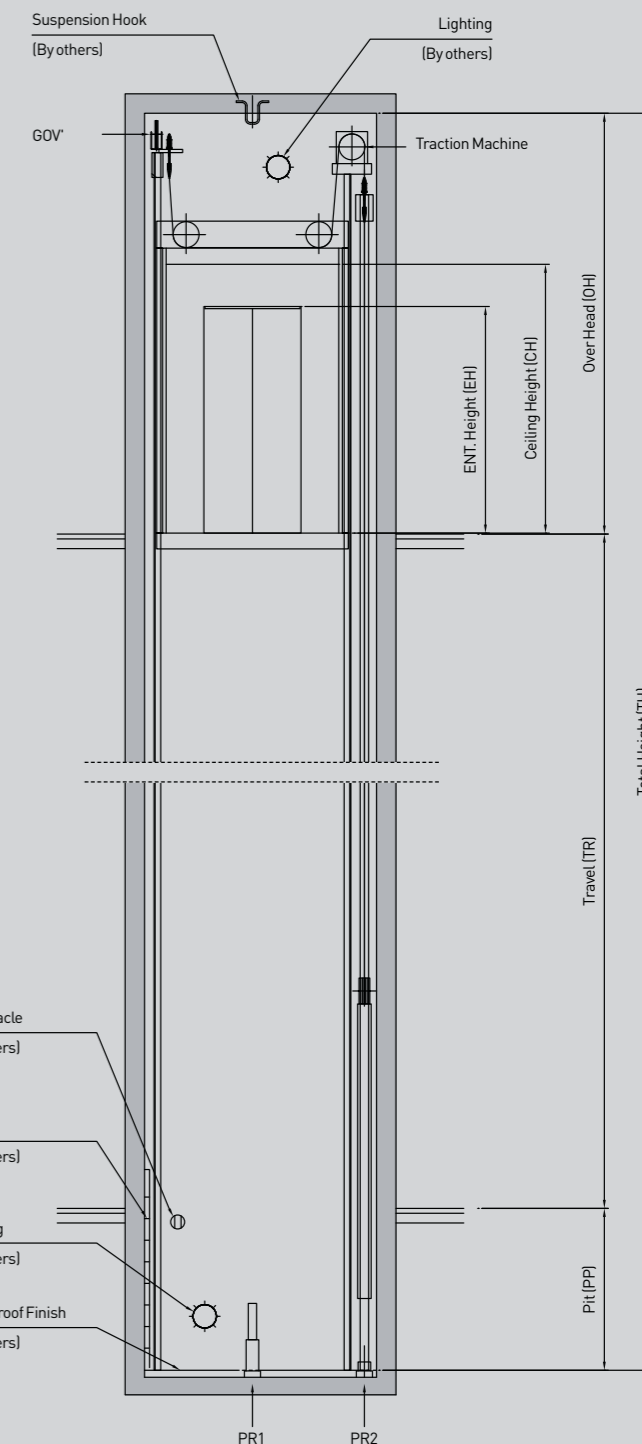

Notes:

1. The lighting of hoistway should be installed less than 500mm from above the ceiling of hoistway and within 500mm above the bottom of the pit. (By others)
2. Machine room temperature should be maintained below 40°C with ventilating fan and/or air conditioner (if necessary) and humidity below 90%

Technical Data

Standard Dimensions and Reactions

	Capacity		Speed (m/s)	Opening Type	Clear Opening	Car Size (mm)	Hoistway Size (mm)	Control Panel Box or Inspection Box (mm)	PIT Reaction (KN)		
	Persons	kg							PR1	PR2	
Center	Manufacturer Standard	6	450	1.0	700	1100 x 1100	1700 x 1500	490	CP	55	46
		7	550			1100 x 1300	1800 x 1700			60	49
		8	630	1.0 ~ 2.0	800	1100 x 1400	1800 x 1750	490	CP	69	56
						1400 x 1100	2000 x 1500				
		9	700	1.0 ~ 2.0	800	1250 x 1400	1900 x 1750	490	CP	73	59
						800	1350 x 1400				
		10	800	1.0 ~ 2.5	900	1600 x 1300	2200 x 1700	490	CP	94	75
		12	900	1.0 ~ 2.5	900	1600 x 1300	2200 x 1700				
		13	1000	1.0 ~ 2.0	900	1600 x 1400	2200 x 1750	490	CP	94	75
							2200 x 2050				
		15	1150	1.0 ~ 2.0	1000	1800 x 1400	2450 x 1750	490	CP	108	85
							2450 x 2050				
18	1350	1.0 ~ 1.5	1000	1800 x 1600	2550 x 2000	490	CP	147	118		
					2550 x 2300					Inpsection box: 240W x 530H CP: In Hoistway	
21	1600	1.0	1100	2000 x 1700	2750 x 2100	490	CP	157	128		
					2750 x 2400					Inpsection box: 240W x 530H CP: In Hoistway	
24	1800	1.0	1100	1600 x 2300	2500 x 2650	490	CP	94x2 ^{Note7}	76x2 ^{Note7}		
										Inpsection box: 240W x 530H CP: In Hoistway	
26	2000	1.0	1200	2100 x 1900	2850 x 2550	490	CP	100x2 ^{Note7}	80x2 ^{Note7}		
										Inpsection box: 240W x 530H CP: In Hoistway	
33	2500	1.0 ~ 1.75	1200	2200 x 2200	2950 x 2850	490	CP	114x2 ^{Note7}	89x2 ^{Note7}		
5	400	1.0	800	1000 x 1100	1600 x 1500					52	44
6	450	1.0	800	1100 x 1100	1700 x 1550	490	CP	60	49		
7	550	1.0	800	1100 x 1300	1700 x 1700						
8	630	1.0 ~ 2.0	900	1100 x 1400	1700 x 1800	490	CP	69	56		
9	700	1.0 ~ 2.0	900	1200 x 1400	1800 x 1800						
10	800	1.0 ~ 2.5	900	1350 x 1400	1950 x 1800	490	CP	77	61		
12	900	1.0 ~ 2.5	900	1300 x 1600	1900 x 2000						
13	1000	1.0 ~ 2.0	900	1100 x 2100	1700 x 2500	490	CP	94	75		
					1750 x 2600					Inpsection box: 240W x 530H CP: In Hoistway	
15	1150	1.0 ~ 2.0	1000	1200 x 2100	2700 x 1550	490	CP	108	85		
					2700 x 1850					Inpsection box: 240W x 530H CP: In Hoistway	
18	1350	1.0 ~ 1.5	1000	1200 x 2100	1800 x 2650	490	CP	147	118		
					1850 x 2650					Inpsection box: 240W x 530H CP: In Hoistway	
21	1600	1.0	1100	1300 x 2300	2050 x 2750	490	CP	157	128		
					2050 x 2860					Inpsection box: 240W x 530H CP: In Hoistway	
24	1800	1.0	1200	1400 x 2400	2150 x 2850	490	CP	94x2 ^{Note7}	76x2 ^{Note7}		
					2150 x 2910					Inpsection box: 240W x 530H CP: In Hoistway	
26	2000	1.0	1200	1500 x 2500	2300 x 2950	490	CP	100x2 ^{Note7}	80x2 ^{Note7}		
										Inpsection box: 240W x 530H CP: In Hoistway	
33	2500	1.0 ~ 1.75	1400	1800 x 2700	2600 x 3150	490	CP	114x2 ^{Note7}	89x2 ^{Note7}		
					Inpsection box: 240W x 530H CP: In Hoistway						

Notes:

- Dimensions are per Hyundai standard or EN81-20, For other countries' codes and specifications requested, please contact us.
- If installing a front and rear double door elevator, please consult with us
- To apply with the safety gear on the counterweight side, please contact us.
- Min. Dimension of Wall Thickness + Finished at Top floor is 250 mm for install of Control Panel
- The Hoistway dimensions(width & depth) assume a maximum horizontal slope of +0 ~ 20mm across the entire length of the hoistway.
- The car and counterweight of 1800 kg ~ 2500 kg is Standard configuration with two buffers.

Overhead & Pit Depth

[Unit: mm]

Duty Load (kg)	Speed (m/s)	Max. Travel (TR(m))	Overhead (OH)	Pit Depth (PP)
400 ~ 550	1.0	50	CH+1470	1150
	1.0	50	CH+1470	1150
630 ~ 1000	1.5	70	CH+1600	1250
	1.75	80	CH+1680	1300
1150	1.0	50	CH+1470	1200
	1.5	70	CH+1600	1300
630 ~ 1150	1.75	80	CH+1680	1400
	2.0	90	CH+1820	1500
800 ~ 1150	2.5	120	CH+2220	1700
	1.0	50	CH+1500	1300
1350 ~ 1600	1.5	70	CH+1600	1400
	1.75	80	CH+1700	1500
1800 ~ 2500	1.0	45	CH+1800	1400
	1.5	90	CH+1900	1600
	1.75	90	CH+2000	1650

Notes:

- CH means the Ceiling Height which was included car internal ceiling
- All dimensions are in compliance with EN81-20
- If apply the trap door at car top, OH shall be increased 200 ~ 400mm
- To apply with the safety gear on counterweight side, Hoistway Width, OH and PIT should be increased. Please contact us.

Works to Be Done by Others

The following construction and electrical works are not included in the elevator contract and shall be performed by others.

Building Work

• **Hoistway**

- Drilling holes in the walls near the elevator entrance on each floor (for the entrance, hall button, hall lantern, etc.) and wall & floor-finish work after elevator installation (including mortar grouting)
- Installation of steel reinforcement to fix jambs on the left and right sides of the entrance
- Installation of ladder for pit inspection
- Finish work after waterproofing of the inside of pit and mounting of the buffer
- Supply and installation of hoistway enclosure or separating beam materials (when necessary)
- Construction of concrete or beam-structured hoistway walls (at least 150 mm thick) where rail brackets can be fixed

- Removal of wedge pins and molds from, and cleaning of, hoistway walls
- Provision of space (at no cost) where construction equipment and materials can be stored
- Destruction of concrete structures which are inconsistent with design plans and necessary finish work
- Installation of lighting fixtures in the hoistway (minimum 100 lux lights to be installed at top and bottom of the hoistway)
- Hoisting beam or hook installation to lift machines to the top of hoistway ceiling
- Miscellaneous (as indicated in drawings)

Electrical Work

• **Hoistway**

- Electrical outlet wiring
- Piping and wiring for electric wires from the monitoring system to the hoistway if such a system is set up
- Piping and wiring for electric wires if a CCTV is installed
- Miscellaneous (as indicated in drawings)
- Power and lighting wiring for the power supply in the hoistway (For installed power capacity, please see drawings for power system construction to be done by other contractors.)
- Installation of a power distribution box including N.F.B. in the electrical room for elevator use (It shall be installed near the hoistway. For installed power capacity, please see drawings for power system construction to be done by other contractors.)

- Power system construction that maintains the line voltage fluctuation of a power-distribution source and a light within the range of +5% to -10% and with in ±2% respectively
- Piping and wiring for outlets used for pit inspection lighting
- Power supply for construction and test operation during installation (at no cost)
- Piping and wiring for an emergency call apparatus between the elevator control unit and the central control room/security office (electric wire specifications: per elevator unit; UTP 0.5 mm x 2P)

* If a steel frame-structured hoistway is set up, please contact us for hoistway planning and other details.

Power Supply Plan

[380V]

Load (kg)	Speed (m/s)	Motor Capacity (kw)	MCCB Capacity of Building (A)		Power Supply Capacity (kVA)		Power Cable Size (mm ²)		Earth Wire Size (mm ²)		Starting Power (kVA/car)
			1 Car	2 Cars	1 Car	2 Cars	1 Car	2 Cars	1 Car	2 Cars	
400	1.0	2.7	20	40	6	10	4	10	10	25	12
450	1.0	3.0	20	40	7	12	4	10	10	25	12
550	1.0	3.7	20	40	7	12	4	10	10	25	14
630	1.0	4.2	20	40	8	14	4	10	10	25	18
	1.5	6.3	32	75	11	19	4	10	10	25	30
	1.75	7.4	32	75	13	22	4	10	10	25	30
700	2.0	9.8	32	75	15	26	6	16	10	25	36
	1.0	4.7	20	40	8	14	4	10	10	25	18
	1.5	7.0	32	75	12	20	4	10	10	25	30
800	1.75	8.3	32	75	14	24	6	16	10	25	30
	2.0	10.3	32	75	16	27	6	16	10	25	42
	1.0	5.3	20	40	9	15	4	10	10	25	18
900	1.5	8.0	32	75	13	22	6	16	10	25	30
	1.75	9.4	32	75	15	26	6	16	10	25	30
	2.0	10.7	32	75	17	29	6	16	10	25	38
1000	2.5	14.7	40	75	20	34	10	25	10	25	48
	1.0	6.7	32	75	11	19	4	10	10	25	24
	1.5	10.0	40	75	15	26	6	16	10	25	42
1150	1.75	11.7	40	75	17	29	10	25	10	25	42
	2.0	13.9	40	75	19	32	10	25	10	25	48
	2.5	17.9	50	100	24	41	16	35	16	35	48
1350	1.0	7.7	32	75	12	20	6	16	10	25	28
	1.5	11.5	40	75	17	29	10	25	10	25	48
	1.75	12.3	40	75	18	31	10	25	10	25	48
1600	2.0	14.1	50	100	21	36	10	25	10	25	48
	2.5	18.8	75	150	26	44	16	35	16	35	52
	1.0	9.2	32	75	13	22	6	16	10	25	28
1800	1.5	13.8	50	100	20	34	10	25	10	25	48
	1.75	16.1	50	100	22	37	16	35	16	35	48
	1.0	10.8	40	75	15	26	6	16	10	25	28
2000	1.5	16.3	50	100	22	37	16	35	16	35	48
	1.75	19.0	75	150	25	43	16	35	16	35	48
	1.0	12.1	40	100	17	29	10	25	10	25	30
2500	1.5	18.1	75	150	24	41	16	35	16	35	44
	1.75	21.1	75	150	28	48	16	35	16	35	50
	1.0	13.4	40	100	18	31	10	25	10	25	32
2500	1.5	20.1	75	150	27	46	16	35	16	35	48
	1.75	23.4	75	150	30	51	25	50	25	50	54
	1.0	16.7	50	100	22	37	16	35	16	35	40
2500	1.5	25.1	75	150	32	54	25	50	25	50	58
	1.75	29.3	75	150	37	63	25	50	25	50	68

* If requested 1.5 or 1.75 m/s for 400-550 kg, Please applied the data of 630 kg to below above table

Global Sales & Service Network

AFRICA, ASIA, EUROPE&CIS, MIDDLE EAST



NORTH/SOUTH AMERICA



HEAD OFFICE & FACTORY SEOUL OFFICE (GLOBAL SALES DIV.)

2091, Gyeongchungdero, Bubal-eup, Icheon-si, Gyeonggi-do, 17366, Korea
5F, East Bldg., Hyundai Group Bldg., 194, Youlgok-ro, Jongno-gu, Seoul, 03127, Korea

AFRICA

EGYPT
T 20-1-066628331
E overseas@iet-hyundailevator.com

ETHIOPIA
T 251-911-503-000
E ieethiopia1@gmail.com

KENYA
T 254-722-667984
E pslyall@skymaxenterprise.com

MOROCCO
T 212-05-2249-0485
E m.ellouze@hyundai-ascenseurs.com

TUNISIA
T 216-71-886-980
E ideal.commercial@gmail.com

ASIA

BANGLADESH
T 88-017-13209212
E zahid@edgeworksbd.com

CAMBODIA
T 855-23-888-399
E project@ggear.com.kh

CHINA
[Head Office(Factory)]
T 86-21-6485-8600
E 2017407@hdel.co.kr

INDIA
T 91-99-7000-0611
E rdmello@kinetic-hyundai.com

INDONESIA
[Service]
T 62-21-3511-355
E marketing@helin.co.id
[New Equipment]
T 62-21-631-8444
E sugiono_nusalim@yahoo.com

MALAYSIA
T 603-7932-1326
E ku.lee@hdel.co.kr

MONGOLIA
T 976-8908-3031
E munkhtuya@hyundai-elevator.mn

MYANMAR

T 951-2305336-37
E info@integral-ltd.com

PAKISTAN
T 92-21-3432-0601-5
E iitcpk@gmail.com

PHILIPPINES
T 632-716-0905
E sales@hyundailevator.ph

SRI LANKA
T 94-11-2623208
E wasantha@abansgroup.com

THAILAND
T 66-2348-8163
E chaichanr@loxley.co.th

UZBEKISTAN
T 998-90-910-1368
E innesa@boinncorp.com

VIETNAM
T 84-913-927-601
E sb.park@hdel.co.kr

EUROPE & CIS

AZERBAIJAN
T 994-12-555-1744-46
E office@astexnika.com

KAZAKHSTAN
T 7-717-245-69-49
E dmitriyo@gmail.com

KYRGYZSTAN
T 996-312-474205
E sales@hyundailift.kg

POLAND
T 48-61-820-85-51
E maciej.dziurkiewicz@omilifts.com

TURKEY
T 90-538-097-5451
E kb.yum@hdel.co.kr

RUSSIA
[Moscow]
T 7-495-668-07-15
E msk@dvc.ru
[Vladi]
T 7-423-220-51-16
E hyundai@dvc.ru

MIDDLE EAST

BAHRAIN
T 973-17-702-468
E elevators@nassgroup.com

IRAQ
T 964-790-133-6499
E arjoon_co@yahoo.com

ISRAEL
T 972-3-9630000
E lgorv@ledico.com

JORDAN
T 962-79-5526-713
E maadbseiso55@gmail.com

KUWAIT
T 965-2245-7925
E info@dealgtc.com

OMAN
T 968-9936-9663
E techno.hyundai@gmail.com

QATAR
T 974-4436-6689, 974-4427-9565
E info@ietg-hyundailevator.com

SAUDI ARABIA
T 966-58-325-4754
E ansar@escco.com.sa

UAE
T 971-4-294-4475
E dubai@bhnoe-hyundai.com

NORTH/SOUTH AMERICA

ARGENTINA
T 5411-3220-2878, 5411-4488-1948
E oqueta@skylift.com.ar

BRAZIL
T 55-11-5071-0978
E james.eom@hdel.com.br

CHILE
T 56-9-22540849
E lcid@cyce.cl

COLOMBIA
T 57-4-444-9297
E sgiraldo@solucionesverticales.com.co

COSTA RICA

T 506-2291-0455
E mv.elevatec@grupomisol.com

DOMINICAN REPUBLIC
T 809-566-7474
E cesar@eleva.com.do

ECUADOR
T 593-2254-2831
E hyundai@a-i.com.ec

EL SALVADOR
T 503-2260-6233
E jc.elevatec@grupomisol.com

GUATEMALA
T 502-2388-0000
E cd.elevatec@grupomisol.com

HONDURAS
T 504-2564-6150, 504-2231-3302
E jc.elevatec@grupomisol.com

MEXICO
T 52-55-5663-2019
E yurich@insertechm.com

NICARAGUA
T 505-2223-5217
E bb.elevatec@grupomisol.com

PANAMA
T 507-381-7422, 507-381-7427
E el.elevatec@grupomisol.com

PERU
T 51-960-121-744
E tl.elevatec@grupomisol.com

PARAGUAY
T 595-2120-1915
E egrau@inelec.com.py

VENEZUELA
T 58-212-232-8263
E ojssimon@gmail.com